

Direct Drive Pneumo Gauge Dimensional Drawing

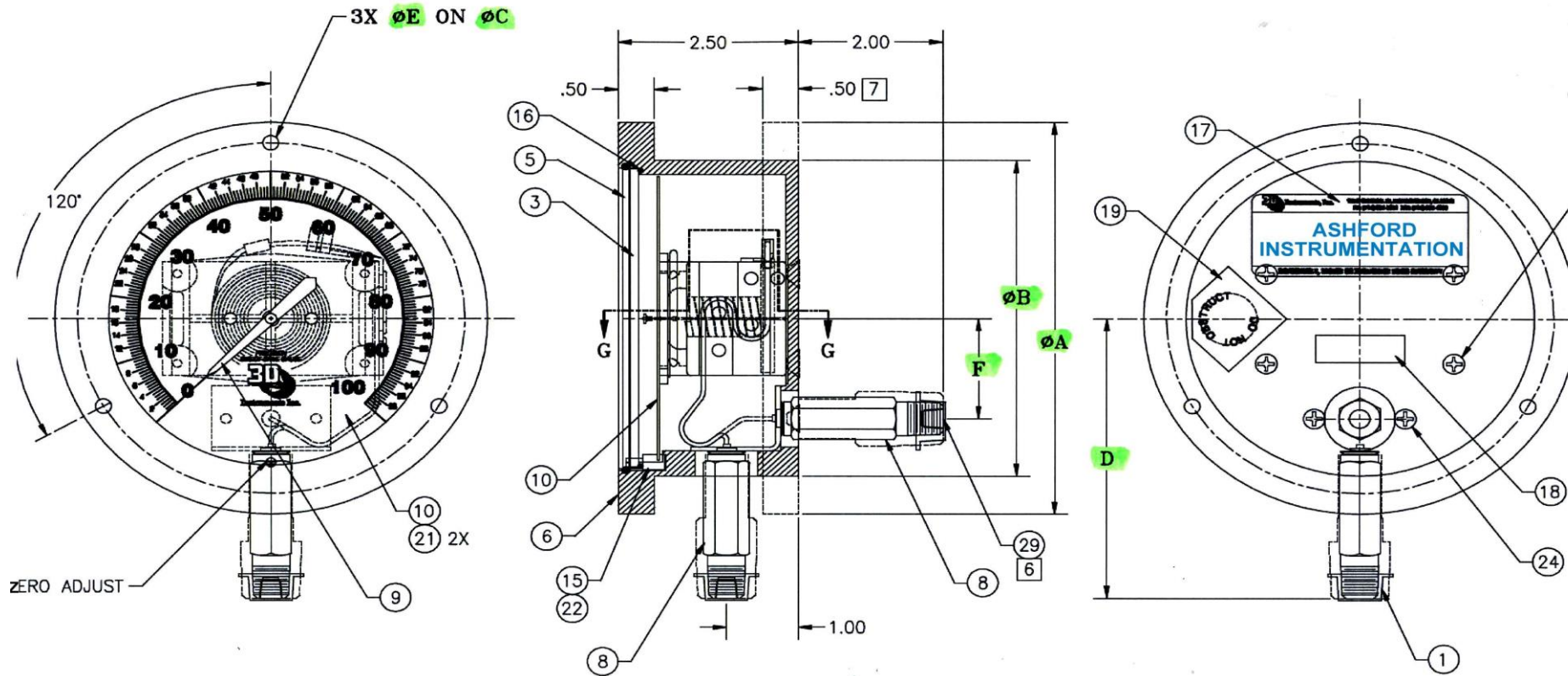

Dimensions In MM							
Diameter	A	B	C	D	E	F	Cut Out
4.5"	152	123	136	107	5.6	39	125
6"	194	160	178	126	7.1	54	162
8.5"	259	224	245	158	7.1	54	227
12"	359	318	342	205	7.1	54	320

PCD

Ashford Instrumentation Ltd
 Unit 2 Fairview Industrial Park
 Hamstreet Road
 Ruckinge Kent
 TN26 2PL
 Tel: 0044 (0)1233 730999
 Fax: 0044 (0)1233 730999
 Email: sales@ashinst.com