

Outline Drawings Standard & Premium Pneumo Gauges

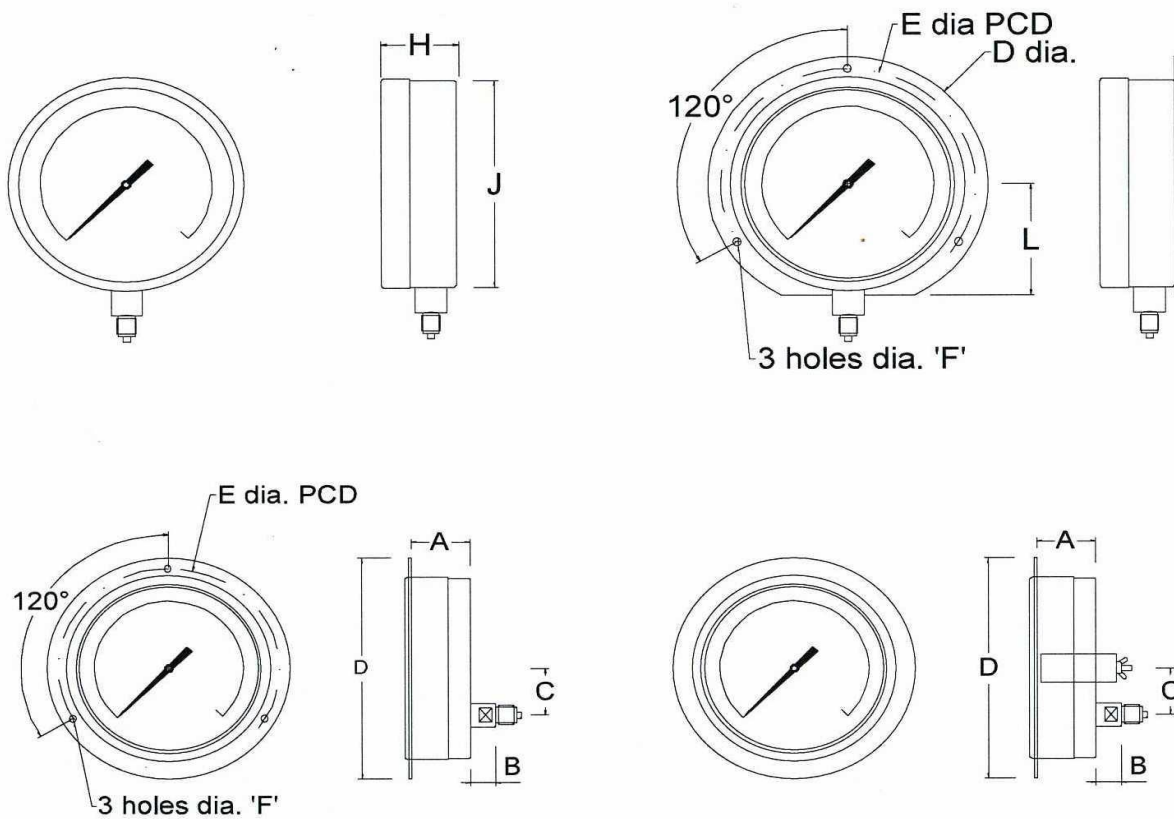

	Gauge Diameter						
	100mm	150mm	160mm SS	200mm	8.5"	250mm	300mm
A	43	58	30	48	48	50	53
B	13	17	17	22	22	20	17
C	27	51	51	51	51	51	51
D	132	194	196	240	262	305	364
E	116	178	178	225	9.38"	276	334
F	5	7	7	7	7	7	7
H	48	64	48	54	54	56	59
J	99	149	159	200	200	250	305

Dimensions In MM

Ashford Instrumentation Ltd
 Unit 2 Fairview Industrial Park
 Hamstreet Road
 Ruckinge
 Kent TN26 2PL
 Tel: 0044 (0) 1233 730999
 Fax: 0044 (0)1233 730999
 Email: sales@ashinst.com